

FLEX I/O AC Digital Input Modules

Catalog Numbers 1794-IA8, 1794-IA8I, 1794-IA16

Topic	Page
Important User Information	2
Environment and Enclosure	3
North American Hazardous Location Approval	4
Prevent Electrostatic Discharge	5
Installing Your AC Digital Input Module	7
Configuring Your AC Input Module	14
Specifications	16

Important User Information

Solid-state equipment has operational characteristics differing from those of electromechanical equipment. Safety Guidelines for the Application, Installation and Maintenance of Solid-state Controls (Publication [SGL-1.1](#) available from your local Rockwell Automation sales office or online at <http://www.rockwellautomation.com/literature/>) describes some important differences between solid-state equipment and hard-wired electromechanical devices. Because of this difference, and also because of the wide variety of uses for solid-state equipment, all persons responsible for applying this equipment must satisfy themselves that each intended application of this equipment is acceptable.

In no event will Rockwell Automation, Inc. be responsible or liable for indirect or consequential damages resulting from the use or application of this equipment.

The examples and diagrams in this manual are included solely for illustrative purposes. Because of the many variables and requirements that are associated with any particular installation, Rockwell Automation, Inc. cannot assume responsibility or liability for actual use based on the examples and diagrams.

No patent liability is assumed by Rockwell Automation, Inc. with respect to use of information, circuits, equipment, or software described in this manual.

Reproduction of the contents of this manual, in whole or in part, without written permission of Rockwell Automation, Inc., is prohibited.

Throughout this manual, when necessary, we use notes to make you aware of safety considerations.

	WARNING: Identifies information about practices or circumstances that can cause an explosion in a hazardous environment, which may lead to personal injury or death, property damage, or economic loss.
	ATTENTION: Identifies information about practices or circumstances that can lead to personal injury or death, property damage, or economic loss. Attentions help you identify a hazard, avoid a hazard and recognize the consequences.
	SHOCK HAZARD: Labels may be on or inside the equipment (for example, drive or motor) to alert people that dangerous voltage may be present.
	BURN HAZARD: Labels may be on or inside the equipment (for example, drive or motor) to alert people that surfaces may reach dangerous temperatures.
IMPORTANT	Identifies information that is critical for successful application and understanding of the product.

Environment and Enclosure



ATTENTION: This equipment is intended for use in a Pollution Degree 2 industrial environment, in overvoltage Category II applications (as defined in EN/IEC 60664-1), at altitudes up to 2000 m (6562 ft) without derating.

This equipment is not intended for use in residential environments and may not provide adequate protection to radio communication services in such environments.

This equipment is supplied as open-type equipment for indoor use. It must be mounted within an enclosure that is suitably designed for those specific environmental conditions that will be present and appropriately designed to prevent personal injury resulting from accessibility to live parts. The enclosure must have suitable flame-retardant properties to prevent or minimize the spread of flame, complying with a flame spread rating of 5V A or be approved for the application if nonmetallic. The interior of the enclosure must be accessible only by the use of a tool. Subsequent sections of this publication may contain more information regarding specific enclosure type ratings that are required to comply with certain product safety certifications.

In addition to this publication, see the following:

- Industrial Automation Wiring and Grounding Guidelines, publication [1770-4.1](#), for additional installation requirements.
- NEMA Standard 250 and EN/IEC 60529, as applicable, for explanations of the degrees of protection provided by enclosures.





ATTENTION: Read this document and the documents listed in the Additional Resources section about installation, configuration, and operation of this equipment before you install, configure, operate, or maintain this product. Users are required to familiarize themselves with installation and wiring instructions in addition to requirements of all applicable codes, laws, and standards.

Installation, adjustments, putting into service, use, assembly, disassembly, and maintenance are required to be carried out by suitably trained personnel in accordance with applicable code of practice. In case of malfunction or damage, no attempts at repair should be made. The module should be returned to the manufacturer for repair. Do not dismantle the module.

North American Hazardous Location Approval

The following modules are North American Hazardous Location approved:
1794-IA8, 1794-IA8I, 1794-IA16.

The Following Information Applies When Operating This Equipment In Hazardous Locations.	Informations sur l'utilisation de cet équipement en environnements dangereux.
<p>Products marked "CL I, DIV 2, GP A, B, C, D" are suitable for use in Class I Division 2 Groups A, B, C, D, Hazardous Locations and nonhazardous locations only. Each product is supplied with markings on the rating nameplate indicating the hazardous location temperature code. When combining products within a system, the most adverse temperature code (lowest "T" number) may be used to help determine the overall temperature code of the system. Combinations of equipment in your system are subject to investigation by the local Authority Having Jurisdiction at the time of installation.</p>	<p>Les produits marqués "CL I, DIV 2, GP A, B, C, D" ne conviennent qu'à une utilisation en environnements de Classe I Division 2 Groupes A, B, C, D dangereux et non dangereux. Chaque produit est livré avec des marquages sur sa plaque d'identification qui indiquent le code de température pour les environnements dangereux. Lorsque plusieurs produits sont combinés dans un système, le code de température le plus défavorable (code de température le plus faible) peut être utilisé pour déterminer le code de température global du système. Les combinaisons d'équipements dans le système sont sujettes à inspection par les autorités locales qualifiées au moment de l'installation.</p>
<div style="display: flex; align-items: center;">  <div> <p>WARNING: Explosion Hazard –</p> <ul style="list-style-type: none"> • Do not disconnect equipment unless power has been removed or the area is known to be nonhazardous. • Do not disconnect connections to this equipment unless power has been removed or the area is known to be nonhazardous. Secure any external connections that mate to this equipment by using screws, sliding latches, threaded connectors, or other means provided with this product. • Substitution of components may impair suitability for Class I, Division 2. </div> </div>	<div style="display: flex; align-items: center;">  <div> <p>AVERTISSEMENT: Risque d'Explosion –</p> <ul style="list-style-type: none"> • Couper le courant ou s'assurer que l'environnement est classé non dangereux avant de débrancher l'équipement. • Couper le courant ou s'assurer que l'environnement est classé non dangereux avant de débrancher les connecteurs. Fixer tous les connecteurs externes reliés à cet équipement à l'aide de vis, loquets coulissants, connecteurs filetés ou autres moyens fournis avec ce produit. • La substitution de composants peut rendre cet équipement inadapté à une utilisation en environnement de Classe I, Division 2. </div> </div>



WARNING: When used in a Class I, Division 2, hazardous location, this equipment must be mounted in a suitable enclosure with proper wiring method that complies with the governing electrical codes.

Prevent Electrostatic Discharge



ATTENTION: This equipment is sensitive to electrostatic discharge, which can cause internal damage and affect normal operation. Follow these guidelines when you handle this equipment:

- Touch a grounded object to discharge potential static.
 - Wear an approved grounding wriststrap.
 - Do not touch connectors or pins on component boards.
 - Do not touch circuit components inside the equipment.
 - Use a static-safe workstation, if available.
 - Store the equipment in appropriate static-safe packaging when not in use.
-

Special Conditions for Safe Use



ATTENTION:

- This product is grounded through the DIN rail to chassis ground. Use zinc plated chromate-passivated steel DIN rail to assure proper grounding. The use of other DIN rail materials (for example, aluminum or plastic) that can corrode, oxidize, or are poor conductors, can result in improper or intermittent grounding. Secure DIN rail to mounting surface approximately every 200 mm (7.8 in.) and use end-anchors appropriately. Be sure to ground the DIN rail properly. Refer to Industrial Automation Wiring and Grounding Guidelines, publication [1770-4.1](#), for more information.
 - Do not remove or replace an Adapter Module while power is applied. Interruption of the backplane can result in unintentional operation or machine motion.
 - Do not remove or replace a terminal base unit while power is applied. Interruption of the backplane can result in unintentional operation or machine motion.
 - If this equipment is used in a manner not specified by the manufacturer, the protection provided by the equipment may be impaired.
-



WARNING:

- When you insert or remove the module while backplane power is on, an electric arc can occur. This could cause an explosion in hazardous location installations.
Be sure that power is removed or the area is nonhazardous before proceeding. Repeated electric arcing causes excessive wear to contacts on both the module and its mating connector. Worn contacts may create electrical resistance that can affect module operation.
 - If you insert or remove the module while backplane power is on, an electric arc can occur. This could cause an explosion in hazardous location installations.
Be sure that power is removed or the area is nonhazardous before proceeding.
-



WARNING: If you connect or disconnect wiring while the field-side power is on, an electrical arc can occur. This could cause an explosion in hazardous location installations. Be sure that power is removed or the area is nonhazardous before proceeding.

Electrical Safety Considerations



ATTENTION:

- This equipment is certified for use only within the surrounding air temperature range of -20...55 °C (-4...131 °F). The equipment must not be used outside of this range.
 - Use only a soft dry anti-static cloth to wipe down equipment. Do not use any cleaning agents.
-



At the end of its life, this equipment should be collected separately from any unsorted municipal waste.

Installing Your AC Digital Input Module

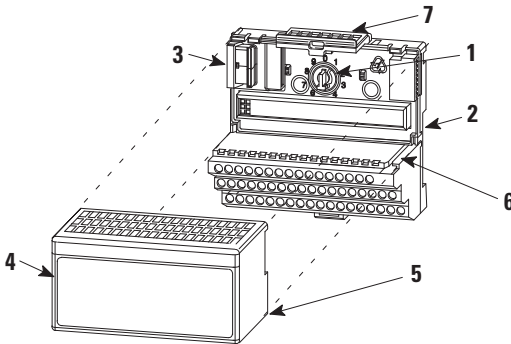

	Description		Description
1	Keyswitch	5	Alignment bar
2	Terminal base	6	Groove
3	Flexbus connector	7	Latching mechanism
4	Module		

The module mounts on a 1794 terminal base.



ATTENTION: During mounting of all devices, be sure that all debris (metal chips, wire strands, etc.) is kept from falling into the module. Debris that falls into the module could cause damage on power up.

1. Rotate the keyswitch (1) on the terminal base (2) clockwise to position [8](#) as required for this type of module.
2. Ensure that the Flexbus connector (3) is pushed all the way to the left to connect with the neighboring terminal base/adapter. **You cannot install the module unless the connector is fully extended.**

3. Make sure the pins on the bottom of the module are straight so they will align properly with the connector in the terminal base.



WARNING: If you insert or remove the module while backplane power is on, an electrical arc can occur. This could cause an explosion in hazardous location installations. Be sure that power is removed or the area is nonhazardous before proceeding.

4. Position the module (4) with its alignment bar (5) aligned with the groove (6) on the terminal base.
5. Press firmly and evenly to seat the module in the terminal base unit. The module is seated when the latching mechanism (7) is locked into the module.

Connecting Wiring for the 1794-IA8

1. **For 1794-TB2, 1794-TB3, or 1794-TB3S** – Connect individual input wiring to even-numbered terminals on the 0...15 row (A) as indicated in the [Wiring Connections for 1794-IA8](#) table.

For 1794-TBN – Connect individual input wiring to numbered terminals on the 16...33 row (B) as indicated in the [Wiring Connections for 1794-IA8](#) table.

2. **For 1794-TB2** – Connect the associated 120V AC power lead (L1) of the input device to the corresponding odd-numbered terminals on the 0...15 row A for each input as indicated in the [Wiring Connections for 1794-IA8](#) table. (The odd-numbered terminals on row A are internally connected to 120V AC L1.)

For 1794-TB3 or 1794-TB3S – Connect the associated 120V AC power lead (L1) of the input device to the corresponding odd-numbered terminals on the 34...51 row (C) or to the corresponding terminal on row (C) for each input as indicated in the [Wiring Connections for 1794-IA8](#) table. (The odd-numbered terminals on row (A) and the terminals of row (C) are internally connected to 120V AC power L1.)

For 1794-TBN – Connect the associated 120V AC power lead (L1) of the input device to the corresponding odd-numbered terminal on the 34...51 row (C) for each input as indicated in the [Wiring Connections for 1794-IA8](#) table. (The 120V AC power terminals of row (C) are internally connected together.)

3. Connect 120V AC power (L1) to terminal 34 on the 34...51 row (C).
4. Connect 120V AC common (L2) to terminal 16 on the 16...33 row (B).
5. If daisy chaining power to the next terminal base, connect a jumper from terminal 51 (+120V AC L1) on this base unit to terminal 34 on the next base unit.
6. If continuing AC common to the next base unit, connect a jumper from terminal 33 (120V common L2) on this base unit to terminal 16 on the next base unit.

Wiring Connections for 1794-IA8

Input	1794-TB2, 1794-TB3, 1794-TB3S		1794-TBN	
	Input Terminal	120V AC Supply	Input Terminal	120V AC Supply
Input 0	A-0	A-1 ⁽¹⁾ /C-35	B-0	C-1 ⁽²⁾
Input 1	A-2	A-3 ⁽¹⁾ /C-36	B-2	C-3 ⁽²⁾
Input 2	A-4	A-5 ⁽¹⁾ /C-37	B-4	C-5 ⁽²⁾
Input 3	A-6	A-7 ⁽¹⁾ /C-38	B-6	C-7 ⁽²⁾
Input 4	A-8	A-9 ⁽¹⁾ /C-39	B-8	C-9 ⁽²⁾
Input 5	A-10	A-11 ⁽¹⁾ /C-40	B-10	C-11 ⁽²⁾
Input 6	A-12	A-13 ⁽¹⁾ /C-41	B-12	C-13 ⁽²⁾
Input 7	A-14	A-15 ⁽¹⁾ /C-42	B-14	C-15 ⁽²⁾
A = Input terminals (Even-numbered terminals 0...14) B = Common terminals C = Power terminals (C-34 and C-51 on 1794-TB2; C-34 to C-51 on 1794-TB3 and 1794-TB3S)			B = Even-numbered input terminals 0...14, AC common terminals 16 and 33 C = Power terminals C-34 and C-51, and odd-numbered input terminals 1...15	

- (1) A-1, 3, 5, 7, 9, 11, 13, and 15 on the 1794-TB2, 1794-TB3, and 1794-TB3S are internally connected in the module to 120V AC L1.
- (2) C-1, 3, 5, 7, 9, 11, 13, and 15 on the 1794-TBN are internally connected in the module to 120V AC L1.

1794-TB2, 1794-TB3, and 1794-TB3S Terminal Base Wiring for 1794-IA8 and 1794-IA16

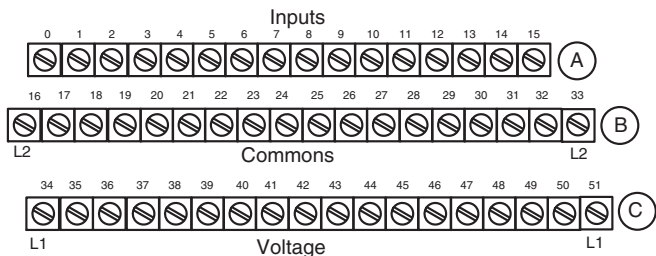

(1794-TB3 shown)

Connect 120V AC L1 power to terminal C-34

Connect 120V AC common L2 to terminal B-16

Use B-33 and C-51 for daisy chaining to the next terminal base unit
(Terminals C-35 thru C-50 not available on the 1794-TB2.)

1794-TBN Terminal Base Wiring for 1794-IA8 and 1794-IA16

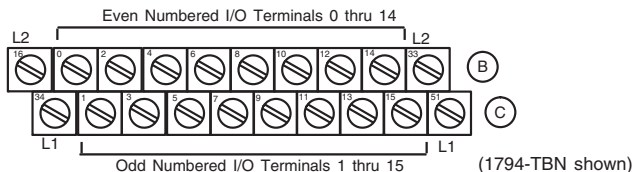

(1794-TBN shown)

L1 = 120V AC - Connect to terminal C-34

L2 = 120V AC common - Connect to terminal B-16

Use B-33 and C-51 for daisy chaining to the next terminal base unit

Connecting Wiring for the 1794-IA16

1. For 1794-TB3 or 1794-TB3S – Connect individual input wiring to numbered terminals on the 0...15 row (A) as indicated in the [Terminal Base Wiring for 1794-IA16](#) table.

For 1794-TBN – Connect individual input wiring to even-numbered terminals on the 16...33 row (B), and to the odd-numbered terminals on

the 34...51 row (C) as indicated in the [Terminal Base Wiring for 1794-IA16](#) table.

2. **For 1794-TB3 or 1794-TB3S** – Connect the associated 120V AC power lead (L1) of the input device to the corresponding terminals on the 34...51 row (C) for each input as indicated in the [Terminal Base Wiring for 1794-IA16](#) table. (The 120V power terminals of row (C) are internally connected together.)

For 1794-TBN – An external terminal strip is needed to distribute 120V AC power (L1) to each device.

3. Connect 120V AC power (L1) to terminal 34 on the 34...51 row (C).
4. Connect 120V AC common (L2) to terminal 16 on the 16...33 row (B).
5. If daisy chaining power to the next terminal base, connect a jumper from terminal 51 (+120V AC L1) on this base unit to terminal 34 on the next base unit.
6. If continuing AC common to the next base unit, connect a jumper from terminal 33 (120V common L2) on this base unit to terminal 16 on the next base unit.

Terminal Base Wiring for 1794-IA16

Input	Input Terminal 1794-TB3, 1794-TB3S	Input Terminal 1794-TBN	120V AC Supply (L1) ⁽¹⁾
Input 0	A-0	B-0	C-35
Input 1	A-1	C-1	C-36
Input 2	A-2	B-2	C-37
Input 3	A-3	C-3	C-38
Input 4	A-4	B-4	C-39
Input 5	A-5	C-5	C-40
Input 6	A-6	B-6	C-41
Input 7	A-7	C-7	C-42
Input 8	A-8	B-8	C-43

Terminal Base Wiring for 1794-IA16

Input	Input Terminal 1794-TB3, 1794-TB3S	Input Terminal 1794-TBN	120V AC Supply (L1) ⁽¹⁾
Input 9	A-9	C-9	C-44
Input 10	A-10	B-10	C-45
Input 11	A-11	C-11	C-46
Input 12	A-12	B-12	C-47
Input 13	A-13	C-13	C-48
Input 14	A-14	B-14	C-49
Input 15	A-15	C-15	C-50
120V AC L1	Power terminals C-34 to C-51 (C-34 and C-51 on 1794-TBN) are internally connected together. Connect 120V AC L1 to C-34.		
120V AC L2	Common terminals B-16 to B-33 (B-16 and B-33 for 1794-TBN) are internally connected together. Connect 120V AC common L2 to terminal B-16.		

(1) When using the 1794-TBN, an external terminal strip is needed to connect the 120V AC power connections.

Connecting Wiring for the 1794-IA8I

1. **For 1794-TB2, 1794-TB3, or 1794-TB3S** – Connect individual input wiring to even-numbered terminals on the 0...15 row (A) as indicated in the Wiring Connections for 1794-IA8I table.

For 1794-TBN – Connect individual input wiring to even-numbered terminals 0...14 on the 16...33 row (B) as indicated in the Wiring Connections for 1794-IA8I table.

2. **For 1794-TB2, 1794-TB3, or 1794-TB3S** – Connect the associated 120V AC common (L2) of the isolated supply to the corresponding odd-numbered terminals on the 0...15 row A for each input as indicated in the Wiring Connections for 1794-IA8I table.

For 1794-TBN – Connect the associated 120V AC common lead (L2) of the isolated supply to the corresponding odd-numbered terminal 1...15 on the 34...51 row (C) as indicated in the Wiring Connections for 1794-IA8I table.

IMPORTANT Individual isolated 120V AC L1 power leads must be run externally to each of the input devices.

Wiring Connections for 1794-IA8I

Input	1794-TB2, 1794-TB3, 1794-TB3S		1794-TBN	
	Input Terminal	120V AC L2 Common	Input Terminal	120V AC L2 Common
Input 0	A-0	A-1	B-0	C-1
Input 1	A-2	A-3	B-2	C-3
Input 2	A-4	A-5	B-4	C-5
Input 3	A-6	A-7	B-6	C-7
Input 4	A-8	A-9	B-8	C-9
Input 5	A-10	A-11	B-10	C-11
Input 6	A-12	A-13	B-12	C-13
Input 7	A-14	A-15	B-14	C-15
A = Even-numbered terminals 0...14 for customer connections; corresponding odd-numbered 120V AC common L2 terminals 1...15 for customer connections from isolated power supply.			B = Even-numbered terminals 0...14 for customer connections; C = Odd-numbered 120V AC common L2 terminals 1...15 for customer connections from isolated power supply.	

1794-TB2, 1794-TB3, and 1794-TB3S Terminal Base Wiring for 1794-IA8I

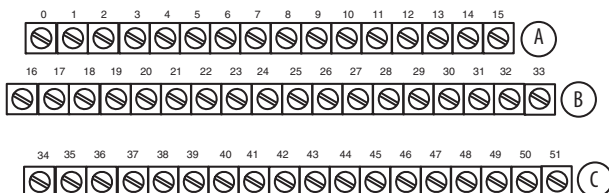

Connect Inputs to even numbered terminals on row (A) (1794-TB3 shown)
 Connect 120V AC common L2 to odd numbered terminals on row (A)

1794-TBN Terminal Base Wiring for 1794-IA8I

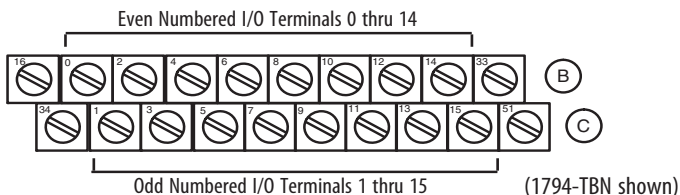

Connect Inputs to even numbered terminals on row (B)
 L2 = 120V AC common - Connect to odd numbered terminals on row (C)

Configuring Your AC Input Module

Image Table Memory Map for the 1794-IA8 and 1794-IA8I Modules

Dec	15	14	13	12	11	10	9	8	7	6	5	4	3	2	1	0
Oct	17	16	15	14	13	12	11	10	7	6	5	4	3	2	1	0
Read									17	16	15	14	13	12	11	10
Write	Not used – set to 0													Filter Time FT 0...7		

Where I = Input
 FT = Input filter time

Image Table Memory Map for the 1794-IA16 Module

Dec	15	14	13	12	11	10	9	8	7	6	5	4	3	2	1	0
Oct	17	16	15	14	13	12	11	10	7	6	5	4	3	2	1	0
Read 1	I15	I14	I13	I12	I11	I10	I9	I8	I7	I6	I5	I4	I3	I2	I1	I0
Write 3	Not used – set to 0										Input Filter FT 12...15			Input Filter FT 0...11		

Where I = Input
FT = Input filter time

Setting the Input Filter Time

You can increase the input filter time (FT) for channels 00...07 (1794-IA8 and 1794-IA8I) and channels 00...15 (1794-IA16) by setting the corresponding bits in the output image table (complementary word) for the module.

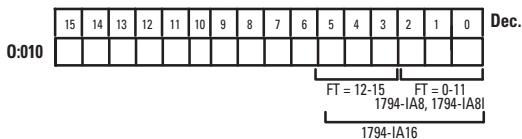

For example, to increase the off-to-on filter time to 12 ms for all inputs at address rack 1, module group 0, set bits, and program as shown below.

Write filter time on system startup.

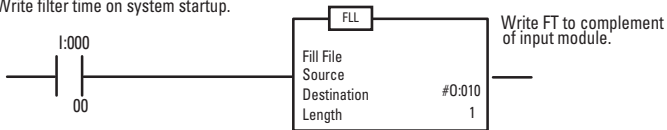

1794-IA8
1794-IA8I

7	6	5	4	3	2	1	0
					1	0	0

= 4 Octal or 4 Decimal

1794-IA16

7	6	5	4	3	2	1	0
		1	0	0	1	0	0

= 44 Octal or 36 Decimal

To increase the filter time, set the bits according to the [Input Filter Time](#) table.

Input Filter Time

Bits			Description	Selected Filter Time	Maximum Filter Time (ms) 1794-IA8		Maximum Filter Time (ms) 1794-IA8I		Maximum Filter Time (ms) 1794-IA16	
02	01	00			Off to On	On to Off	Off to On	On to Off	Off to On	On to Off
			Filter Time – Inputs 00...11							
			Filter Time – Inputs 12...15							
0	0	0	Filter time 0 (default)	256 μ s	8.4	26.4	8.4	26.4	7.5	26.5
0	0	1	Filter time 1	512 μ s	8.6	26.6	8.6	26.6	8	27
0	1	0	Filter time 2	1 ms	9	27	9	27	9	28
0	1	1	Filter time 3	2 ms	10	28	10	28	10	29
1	0	1	Filter time 4	4 ms	12	30	12	30	12	31
1	0	1	Filter time 5	8 ms	16	34	16	34	16	35
1	1	0	Filter time 6	16 ms	24	42	24	42	24.5	44
1	1	1	Filter time 7	32 ms	40	58	40	58	42	60.5

Specifications

Specifications – 1794-IA8, 1794-IA8I

Attribute	1794-IA8	1794-IA8I
Number of inputs	8, nonisolated	8, isolated
Recommended terminal base unit	1794-TBN, 1794-TB2, 1794-TB3, 1794-TB3S, 1794-TBKD, 1794-TB3K, 1794-TB3SK, 1794-TBNK	
On-state voltage, min	65V AC	
On-state voltage, nom	120V AC	
On-state voltage, max	132V AC	
On-state current, min ⁽¹⁾	7.1 mA	

Specifications – 1794-IA8, 1794-IA8I

Attribute	1794-IA8	1794-IA8I
On-state current, max	14.32 mA	
Off-state voltage, max	43V AC	
Off-state current, min	2.9 mA	
Nominal input impedance	10.6 k Ω	
Nominal input current	12 mA @ 120V AC	
Isolation voltage	120V (continuous), Basic Insulation Type Type tested @ 1250V AC for 60 s, between field side and system No isolation between individual channels	120V (continuous), Basic Insulation Type Type tested @ 1240V AC for 60 s, between field side and system Isolation between individual channels.
Input filter time	See Input Filter Time table	
Flexbus current	30 mA @ 5V DC	
Power dissipation, max	4.5 W @ 132V AC	
Thermal dissipation, max	15.3 BTU/hr @ 132V AC	

(1) AC inputs compatible with proximity switches with leakage ratings of $I_{leak} < 2.5$ mA and I_{on} minimum = 5 mA

Specifications – 1794-IA16

Attribute	Value
Number of inputs	16, nonisolated
Module location	1794-TB3, 1794-TB3S, 1794-TBN ⁽²⁾ , 1794-TB3K, 1794-TB3SK, 1794-TBNK
On-state voltage, min	74V AC
On-state voltage, nom	120V AC
On-state voltage, max	132V AC
On-state current, min ⁽¹⁾	5.49 mA
On-state current, max	14.81 mA
Off-state voltage, max	20V AC
Off-state current, min	2.9 mA

Specifications – 1794-IA16

Attribute	Value
Nominal input impedance	10 k Ω
Nominal input current	12 mA @ 120V AC
Isolation voltage	120V (continuous), Basic Insulation Type Type tested @ 1264V AC for 60 s, between field side and system No isolation between individual channels
Input filter time	See Input Filter Time table
Flexbus current	20 mA
Power dissipation, max	6.4 W @ 132V AC
Thermal dissipation, max	21.8 BTU/hr @ 132V AC

- AC inputs compatible with proximity switches with leakage ratings of $I_{leak} < 2.5$ mA and I_{on} minimum = 5 mA
- Auxiliary terminal strips are required when using the 1794-TBN.

General Specifications

Attribute	1794-IA8, 1794-IA8I	1794-IA16
Terminal base screw torque	Determined by installed terminal base	
Dimensions, approx. (H x W x D)	94 x 94 x 69 mm (3.7 x 3.7 x 2.7 in.)	
Indicators (field side indication)	8 yellow status indicators	16 yellow status indicators
External AC power supply voltage, nom	120V AC	
External AC power voltage range	65...132V AC	74...132V AC
North American temperature code	T4A	T4
Keyswitch position	8	
Enclosure type rating	None (open-style)	
Wire size	Determined by installed terminal base	
Wiring category ⁽¹⁾	2 – on signal ports	

- Use this Conductor Category information for planning conductor routing as described in the appropriate System Level Installation Manual. Also refer to Industrial Automation Wiring and Grounding Guidelines, publication [1770-4.1](#), for more information.

Environmental Specifications

Attribute	1794-IA8, 1794-IA8I	1794-IA16
Operating temperature	IEC 60068-2-1 (Test Ad, operating cold), IEC 60068-2-2 (Test Bd, operating dry heat), IEC 60068-2-14 (Test Nb, operating thermal shock):	
	-20...55 °C (-4...131 °F)	0...55 °C (32...131 °F)
Storage temperature	IEC 60068-2-1 (Test Ab, unpackaged nonoperating cold), IEC 60068-2-2 (Test Bb, unpackaged nonoperating dry heat), IEC 60068-2-14 (Test Na, unpackaged nonoperating thermal shock): -40...85 °C (-40...185 °F)	
Temperature, surrounding air, max	55 °C (131 °F)	
Relative humidity	IEC 60068-2-30 (Test Db, Unpackaged Damp Heat): 5...95% noncondensing	
Vibration	IEC60068-2-6 (Test Fc, Operating): 5 g @ 10...500 Hz	
Shock, operating	IEC60068-2-27 (Test Ea, Unpackaged shock): 30 g	
Shock, nonoperating	IEC60068-2-27 (Test Ea, Unpackaged shock): 50 g	
Emissions	IEC 61000-6-4	
ESD immunity	IEC 61000-4-2: 6 kV contact discharges 8 kV air discharges	
Radiated RF immunity	IEC 61000-4-3: 10V/m with 1 kHz sine-wave 80% AM from 80...2000 MHz 10V/m with 200 Hz 50% Pulse 100% AM @ 900 MHz 10V/m with 200 Hz 50% Pulse 100% AM @ 1890 MHz 1V/m with 1 kHz sine-wave 80% AM from 2000...2700 MHz	

Environmental Specifications

Attribute	1794-IA8, 1794-IA8I	1794-IA16
EFT/B immunity	IEC 61000-4-4: ±2 kV @ 5 kHz on power ports ±2 kV @ 5 kHz on signal ports	
Surge transient immunity	IEC 61000-4-5: ±1 kV line-line(DM) and ±2 kV line-earth(CM) on signal ports	
Conducted RF immunity	IEC 61000-4-6: 10V rms with 1 kHz sine-wave 80% AM from 150 kHz. . . 80 MHz	

Certifications

Certifications (When Product is Marked) ⁽¹⁾	Value
c-UL-us	<p>(1794-IA8, 1794-IA8I only) UL Listed Industrial Control Equipment. See UL File E65584.</p> <p>(1794-IA16 only) UL Listed Industrial Control Equipment, certified for US and Canada. See UL File E322657. UL Listed for Class I, Division 2 Group A,B,C,D Hazardous Locations, certified for U.S. and Canada. See UL File E334470.</p>
CSA	<p>(1794-IA8, 1794-IA8I only) CSA Certified Process Control Equipment. See CSA File LR54689C.</p> <p>CSA Certified Process Control Equipment for Class I, Division 2 Group A,B,C,D Hazardous Locations. See CSA File LR69960C.</p>
CE	<p>European Union 2014/30/EU EMC Directive, compliant with:</p> <ul style="list-style-type: none"> • EN 61326-1; Meas./Control/Lab., Industrial Requirements • EN 61000-6-4; Industrial Emissions • EN 61131-2; Programmable Controllers (Clause 8, Zone A & B) <p>European Union 2014/35/EU LVD, compliant with:</p> <ul style="list-style-type: none"> • EN 61131-2; Programmable Controllers (Clause 11) <p>European Union 2011/65/EU RoHS, compliant with:</p> <ul style="list-style-type: none"> • EN 50581; Technical documentation

Certifications

Certifications (When Product is Marked)⁽¹⁾	Value
KC	Korean Registration of Broadcasting and Communications Equipment, compliant with: <ul style="list-style-type: none">• Article 58-2 of Radio Waves Act, Clause 3
EAC	<ul style="list-style-type: none">• Russian Customs Union TR CU 020/2011 EMC Technical Regulation• Russian Customs Union TR CU 004/2011 LV Technical Regulation
RCM	Australian Radiocommunications Act, compliant with: <ul style="list-style-type: none">• EN 61000-6-4; Industrial Emissions

(1) See the Product Certification link at <http://www.rockwellautomation.com/global/certification/overview.page> for Declaration of Conformity, Certificates, and other certification details.

Notes:

Rockwell Automation Support

Use the following resources to access support information.

Technical Support Center	Knowledgebase Articles, How-to Videos, FAQs, Chat, User Forums, and Product Notification Updates.	www.rockwellautomation.com/knowledgebase
Local Technical Support Phone Numbers	Locate the phone number for your country.	www.rockwellautomation.com/global/support/get-support-now.page
Direct Dial Codes	Find the Direct Dial Code for your product. Use the code to route your call directly to a technical support engineer.	www.rockwellautomation.com/global/support/direct-dial.page
Literature Library	Installation Instructions, Manuals, Brochures, and Technical Data.	www.rockwellautomation.com/literature
Product Compatibility and Download Center (PCDC)	Get help determining how products interact, check features and capabilities, and find associated firmware.	www.rockwellautomation.com/global/support/pcdc.page

Documentation Feedback

Your comments will help us serve your documentation needs better. If you have any suggestions on how to improve this document, complete the How Are We Doing? form at http://literature.rockwellautomation.com/idc/groups/literature/documents/du/ra-du002_-en-e.pdf.

Rockwell Automation maintains current product environmental information on its website at <http://www.rockwellautomation.com/rockwellautomation/about-us/sustainability-ethics/product-environmental-compliance.page>.

Allen-Bradley, Rockwell Automation, FLEX I/O, Rockwell Software, and TechConnect are trademarks of Rockwell Automation, Inc. Trademarks not belonging to Rockwell Automation are property of their respective companies.

Rockwell Otomasyon Ticaret A.Ş., Kar Plaza İş Merkezi E Blok Kat:6 34752 İçerenköy, İstanbul, Tel: +90 (216) 5698400

www.rockwellautomation.com

Power, Control and Information Solutions Headquarters

Americas: Rockwell Automation, 1201 South Second Street, Milwaukee, WI 53204-2496 USA, Tel: (1) 414.382.2000, Fax: (1) 414.382.4444
Europe/Middle East/Africa: Rockwell Automation NV, Pegasus Park, De Kleitlaan 12a, 1831 Diegem, Belgium, Tel: (32) 2 663 0600, Fax: (32) 2 663 0640
Asia Pacific: Rockwell Automation, Level 14, Core F, Cyberport 3, 100 Cyberport Road, Hong Kong, Tel: (852) 2887 4788, Fax: (852) 2508 1846

Publication 1794-IN102D-EN-P - July 2018

Supersedes Publication 1794-IN102C-EN-P - July 2015

Copyright © 2018 Rockwell Automation, Inc. All rights reserved.